

ANGEL 5 300 WIDE CHANDELIER

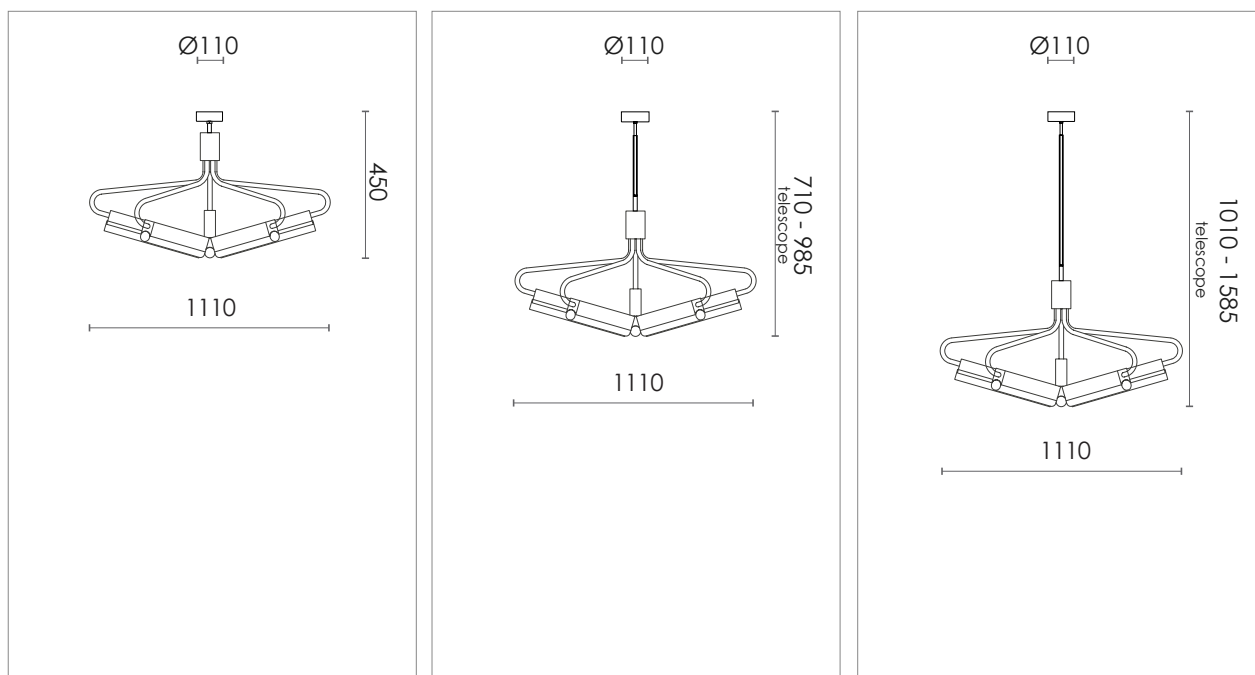

DESIGN SPECIFICATIONS

DIMENSIONS (mm)	W 1110 x H 450 W 1110 x H 710-985 W 1110 x H 1010-1585
WEIGHT (kg)	- / - / -
MATERIALS	THE LAMP IS MADE FROM CLEAR LACQURED BRASS, STEEL OR POWDER COATED STEEL.
CORD (mm)	NO
ENVIRONMENT	INDOOR
DESIGN BY	NICLAS HOFLIN
DESIGN YEAR	2019

ELECTRICAL SPECIFICATIONS

SWITCH	NO
BULB HOLDER	S14S
LIGHT SOURCE	INCLUDED 5 X 4,5 W DIMMABLE LED - 2700 K
DIMMABLE	YES
MAX (W)	22,5 W LED
VOLTAGE	230 / 240
CLASS	1
IP	20

COLOURS

	BLACK	H 450 ART.NO. 916131005	H 710-985 ART.NO. 916132005	H 1010-1585 ART.NO. 916133005
	BRASS	H 450 ART.NO. 916131001	H 710-985 ART.NO. 916132001	H 1010-1585 ART.NO. 916133001
	BRONZE-COLOR	H 450 ART.NO. 916131223	H 710-985 ART.NO. 916132223	H 1010-1585 ART.NO. 916133223
	STEEL	H 450 ART.NO. 916131500	H 710-985 ART.NO. 916132500	H 1010-1585 ART.NO. 916133500